

DOLPHIN DOORS



THE MOST
SECURE DOORS

THE MOST *secure* DOORS

dolphindoors.com



dolphindoors.com

INNOVATION
starts at
THE DOOR

security doors

**With our designs that combine security and aesthetics,
and thanks to our innovative technologies,**
we offer our user-friendly products to your service while
maintaining our quality at the highest level.



Security
Doors



Designed specifically for you...

Dolphin Doors Limited carefully thinks and puts into practice every detail that the consumer needs exceeding expectations. It continuously aligns with changing habits and behaviors, offering functional and aesthetic solutions in various areas, namely exterior doors, apartment doors, interior room doors, emergency exit doors, and other particular uses.

It executes its innovative works in a flexible way for all sectors, where it produces solutions and works to achieve the best results by considering all factors while implementing its designs. By applying the Quality Management System in accordance with the international certificates it has at all stages of production, It prioritizes quality over time.

Management, design, application, and post-implementation services, and aims to maximize customer satisfaction. With its R&D and design investments, it offers DOLPHIN DOORS-specific innovation and applications for the users. Besides, I use advanced technology in all units and ensure positive results in the product phase; in this way export my product to many countries, such as Europe and the US continent.

The satisfaction of its customers in approximately 50 countries of the world with its expert marketing, sales, and afterward-sales service team; As a global brand, it aims to keep it always at the top with exemplary service and correct guidance.

Security
Doors



Sustainable Environment and Production

For a sustainable environment, our company meets all its energy needs from solar energy panels, thus, the electricity needs of 1.5 million kWh are met from renewable energy.

In this way, we will prevent carbon emissions equivalent to the amount of greenhouse gas that 510.000 trees can reduce.

dolphindoors.com



new collection

Tesano - 10th Mukose St,- Abeka,
Accra - Ghana
+233 302 986 345 +233 302 252 027
info@dolphindoors.com

Road of Justice - Obom, Kasoa
Central Region - Ghana
+233 302 986 345 +233 302 252 027

13 B E X



PATENTED
2023/001034





14
B E X



PATENTED
2023/001034



9018 R

15 B E X

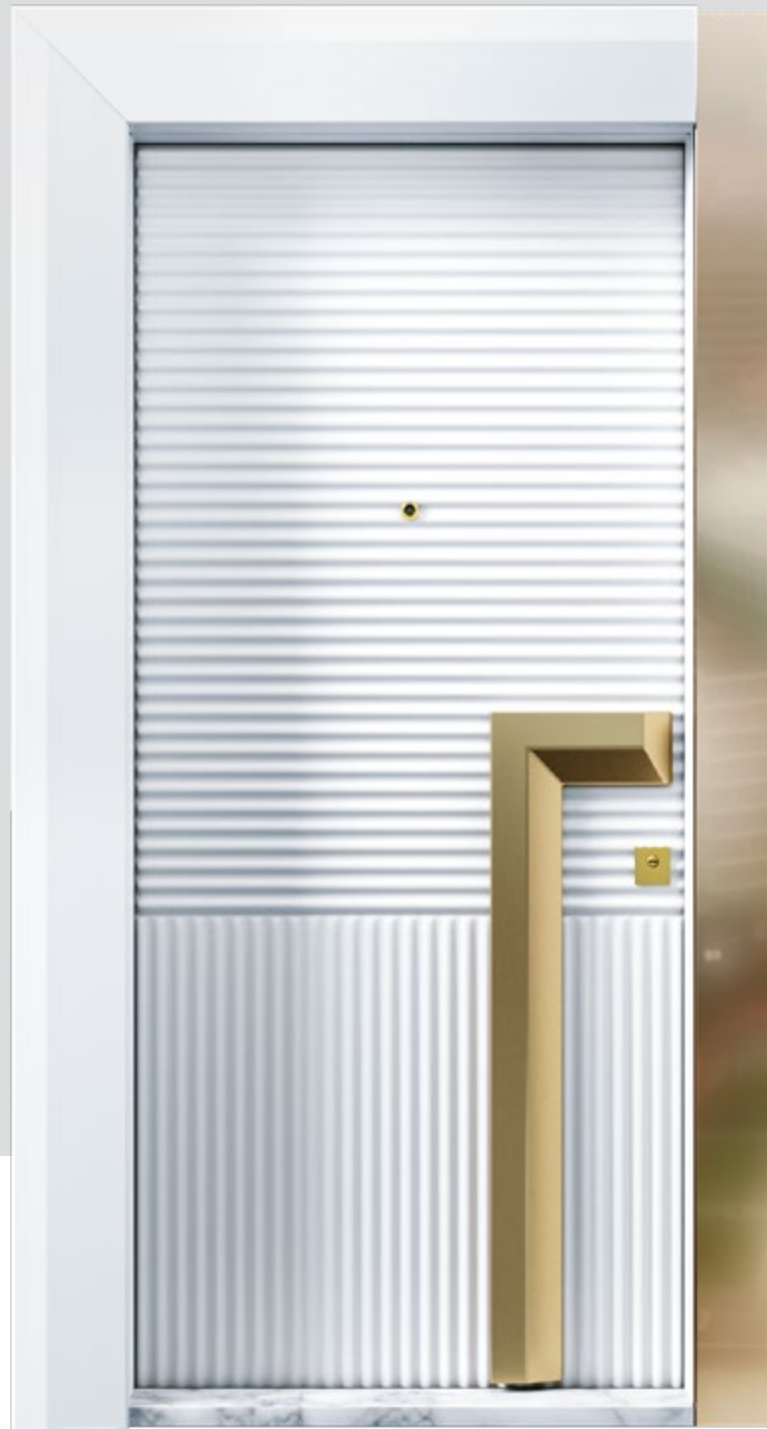

PATENTED
2023/001034

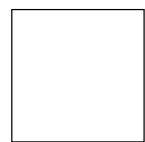

9003 R



9018 R





16

B E X

PATENTED
2023/001034



17 B E X



PATENTED
2023/001034



LD 167



18 B E X



PATENTED
2023/001034

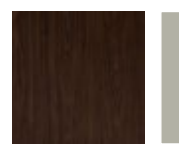

UNL 246



7044 R

19 B E X



PATENTED
2023/001034



7036 R



20 B E X



PATENTED
2023/001034

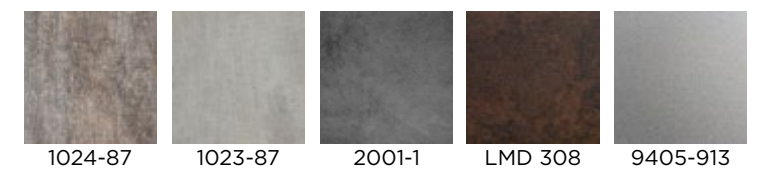

21 B E X



PATENTED
2023/001034





22

B E X

PATENTED
2023/001034

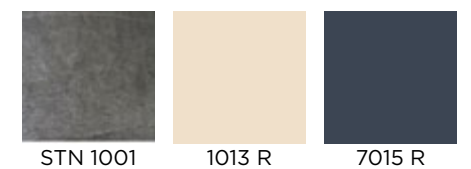

23 B E X



PATENTED
2023/001034





24 B E X



PATENTED
2023/001034

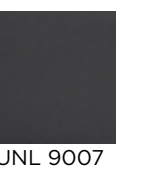

UNL 9007

25 B E X



PATENTED
2023/001034





26

B E X



PATENTED
2023/001034



3509-03

27

B E X



PATENTED
2023/001034

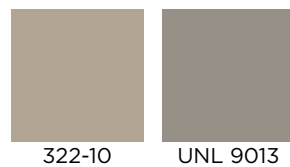



28

B E X



PATENTED
2023/001034



29

B E X



PATENTED
2023/001034

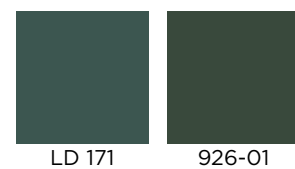



30

B E X



PATENTED
2023/001034



31 B E X



PATENTED
2023/001034





32

B E X



PATENTED
2023/001034

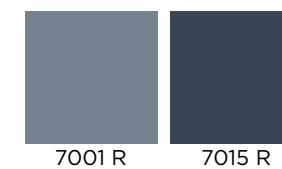

33 B E X



PATENTED
2023/001034



664-01



34

B E X



PATENTED
2023/001034



9006 R

35
B E X



PATENTED
2023/001034

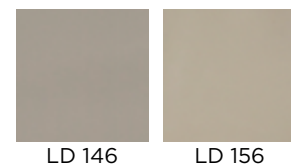



36

B E X



PATENTED
2023/001034

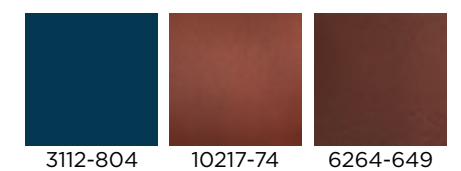

37 B E X



PATENTED
2023/001034





38

B E X



PATENTED
2023/001034

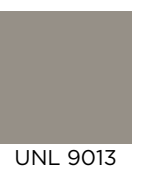

39

B E X



PATENTED
2023/001034

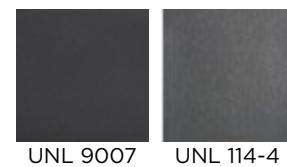



40

B E X

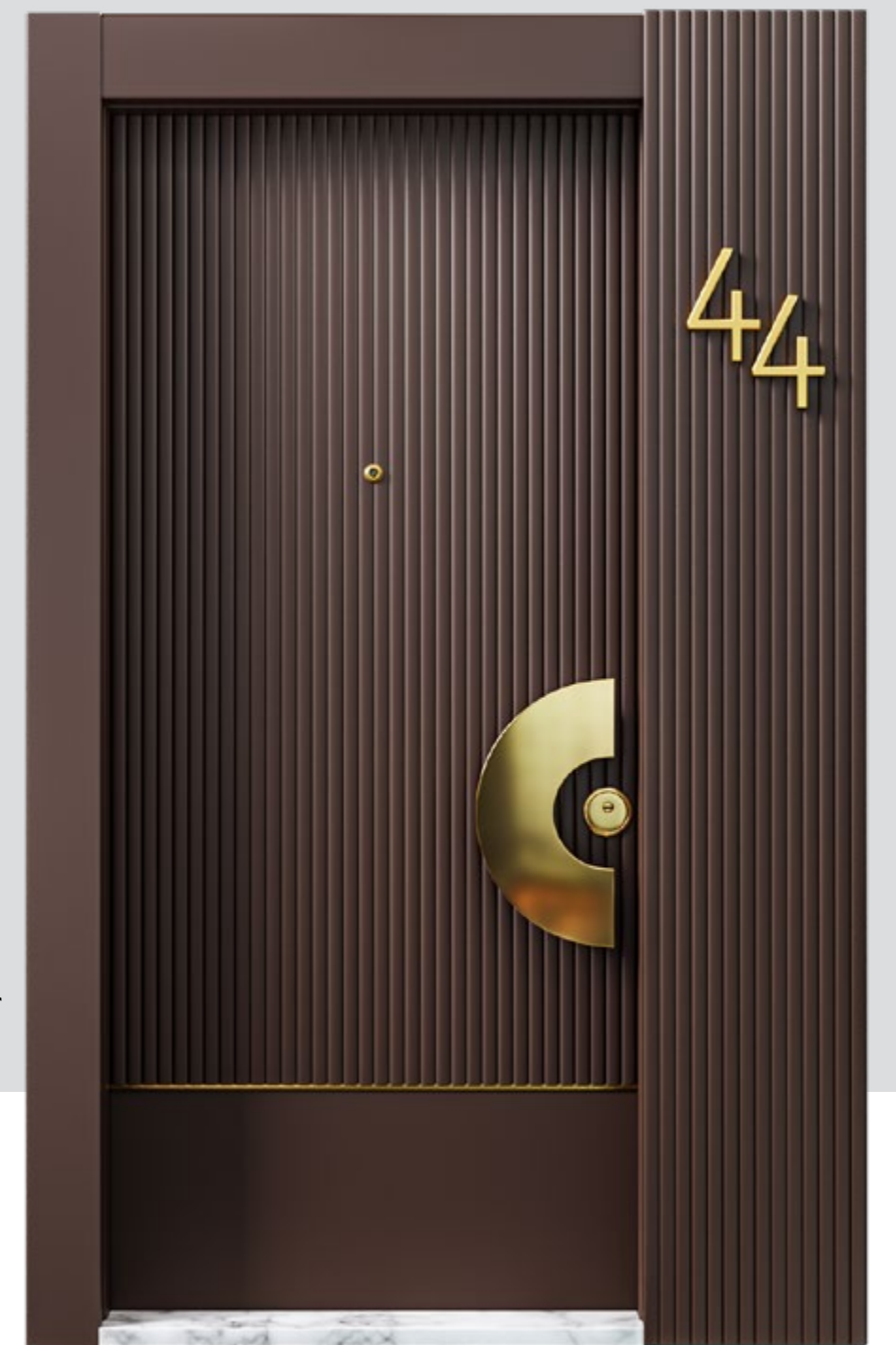

PATENTED
2023/001034

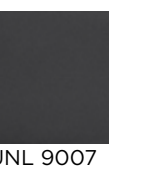

41 B E X



PATENTED
2023/001034





42

B E X

PATENTED
2023/001034

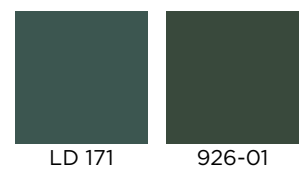

43 B E X



PATENTED
2023/001034

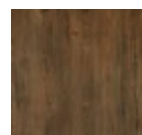

UNL 2048



44
B E X

PATENTED
2023/001034

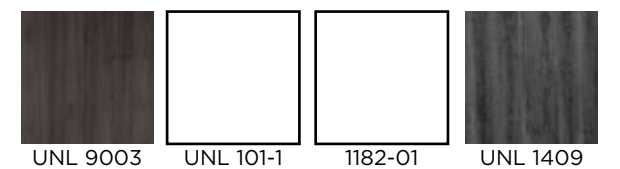

45 B E X



PATENTED
2023/001034

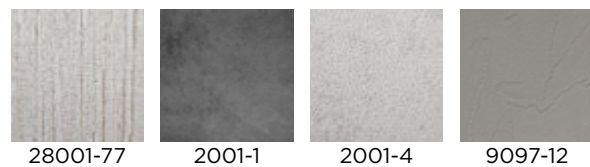



46

B E X



PATENTED
2023/001034

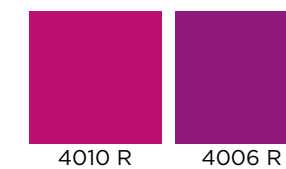

47 B E X



PATENTED
2023/001034

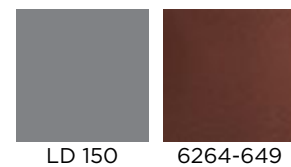



48

B E X



PATENTED
2023/001034

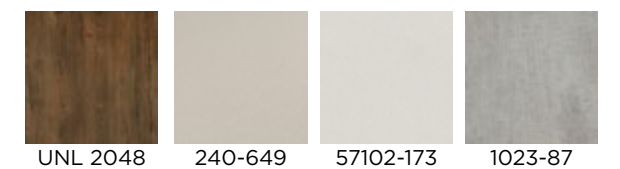



Exclusive Doors

01 BEX

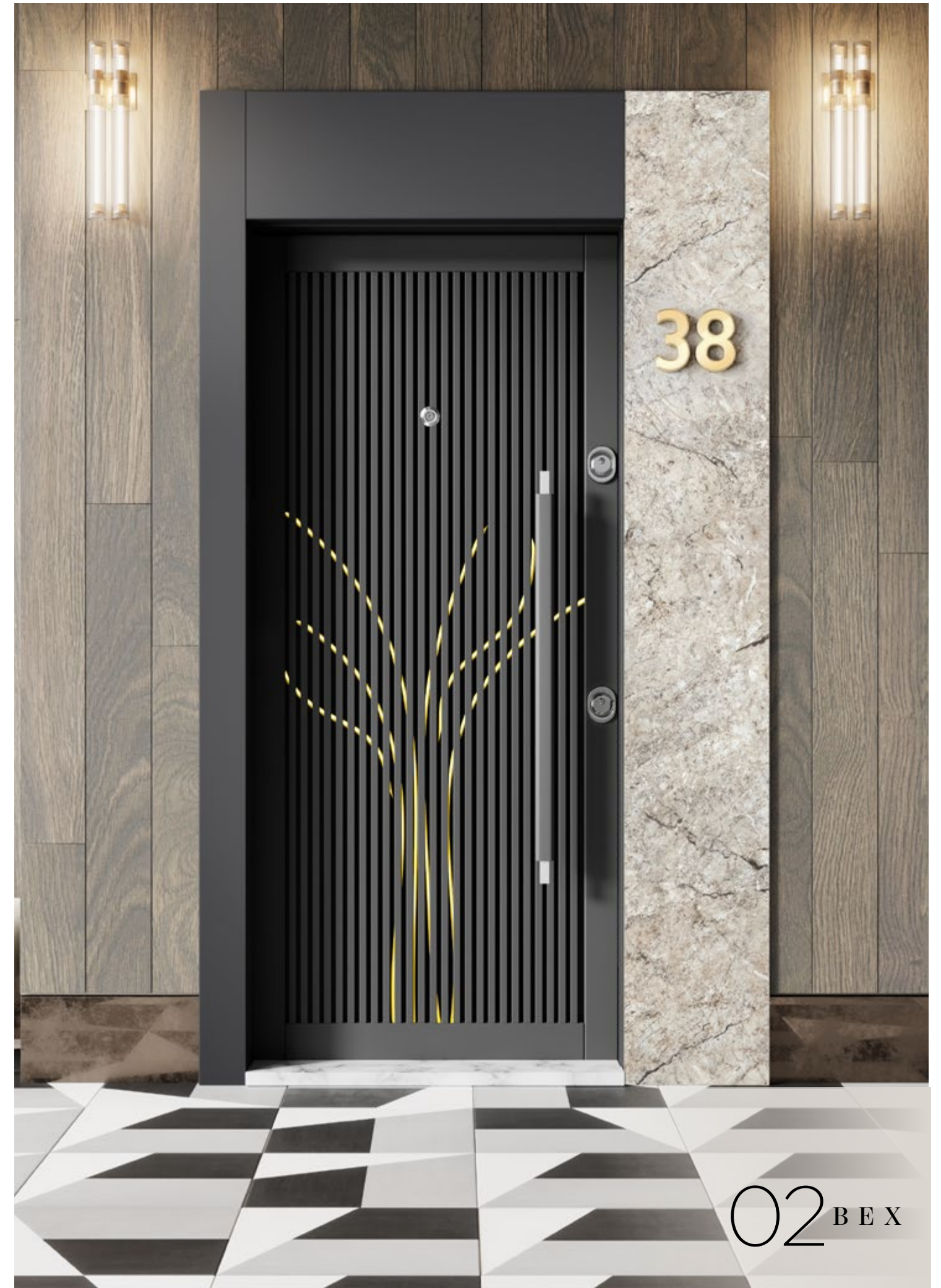

Exclusive Doors

02 BEX

01 B E X



XXX

02 B E X



XXX

01 B E X



PVC EMBOSSED DOORS

02 B E X



PVC EMBOSSED DOORS

01 B E X



PVC EMBOSSED DOORS

02 B E X



PVC EMBOSSED DOORS

01 B E X

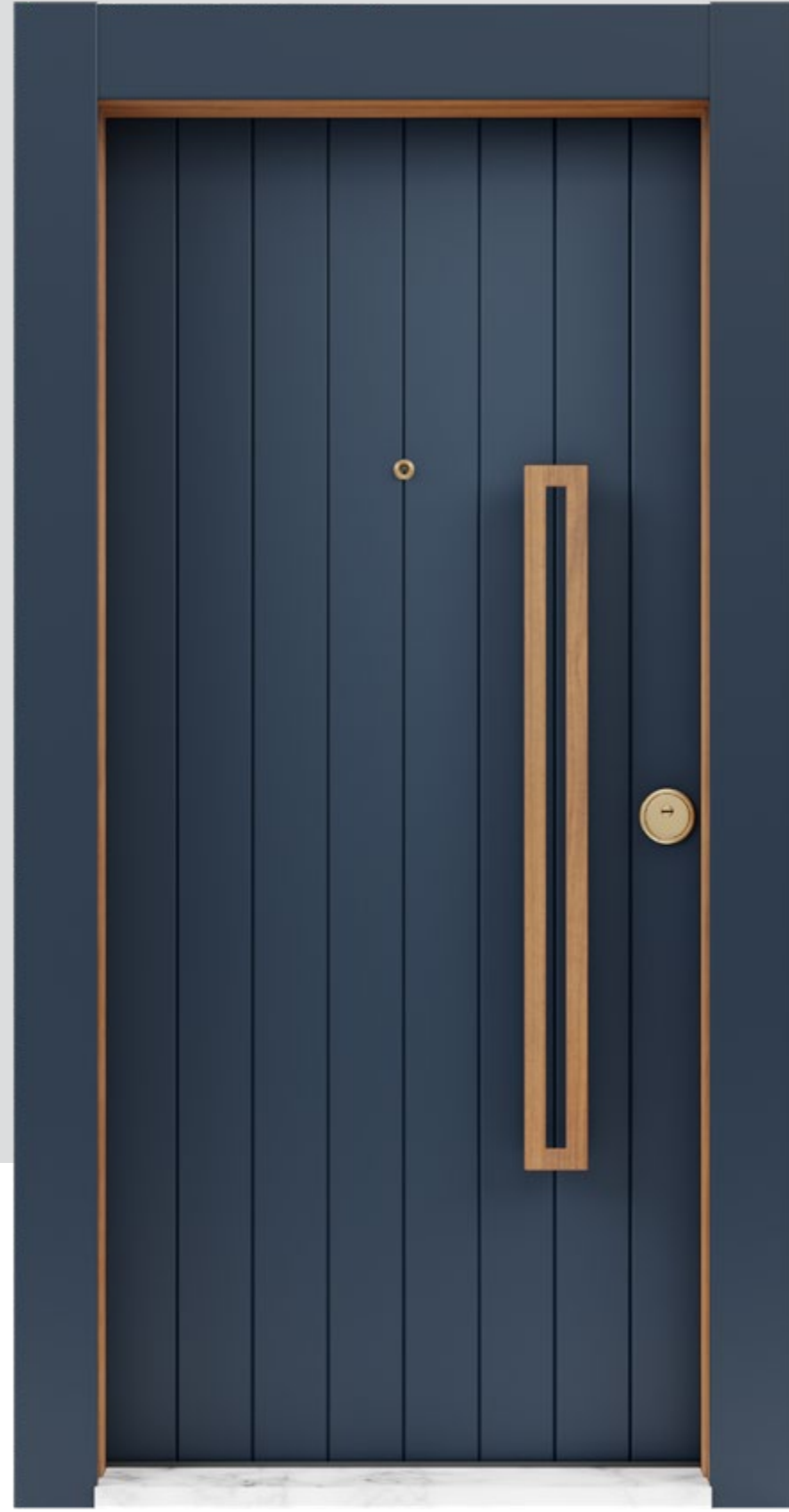

PVC EMBOSSED DOORS

02 B E X



PVC EMBOSSED DOORS

01 B E X

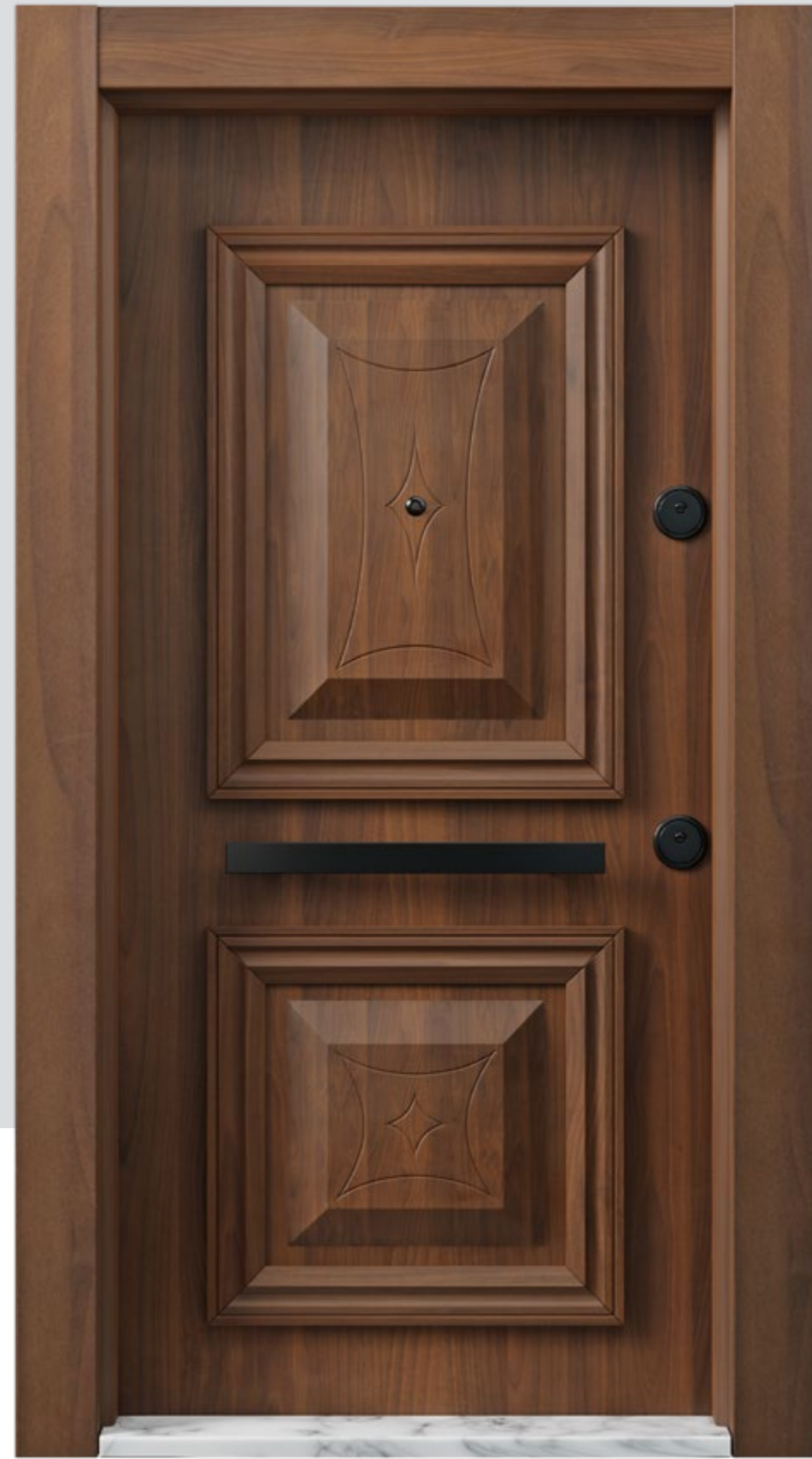

PVC EMBOSSED DOORS

02 B E X

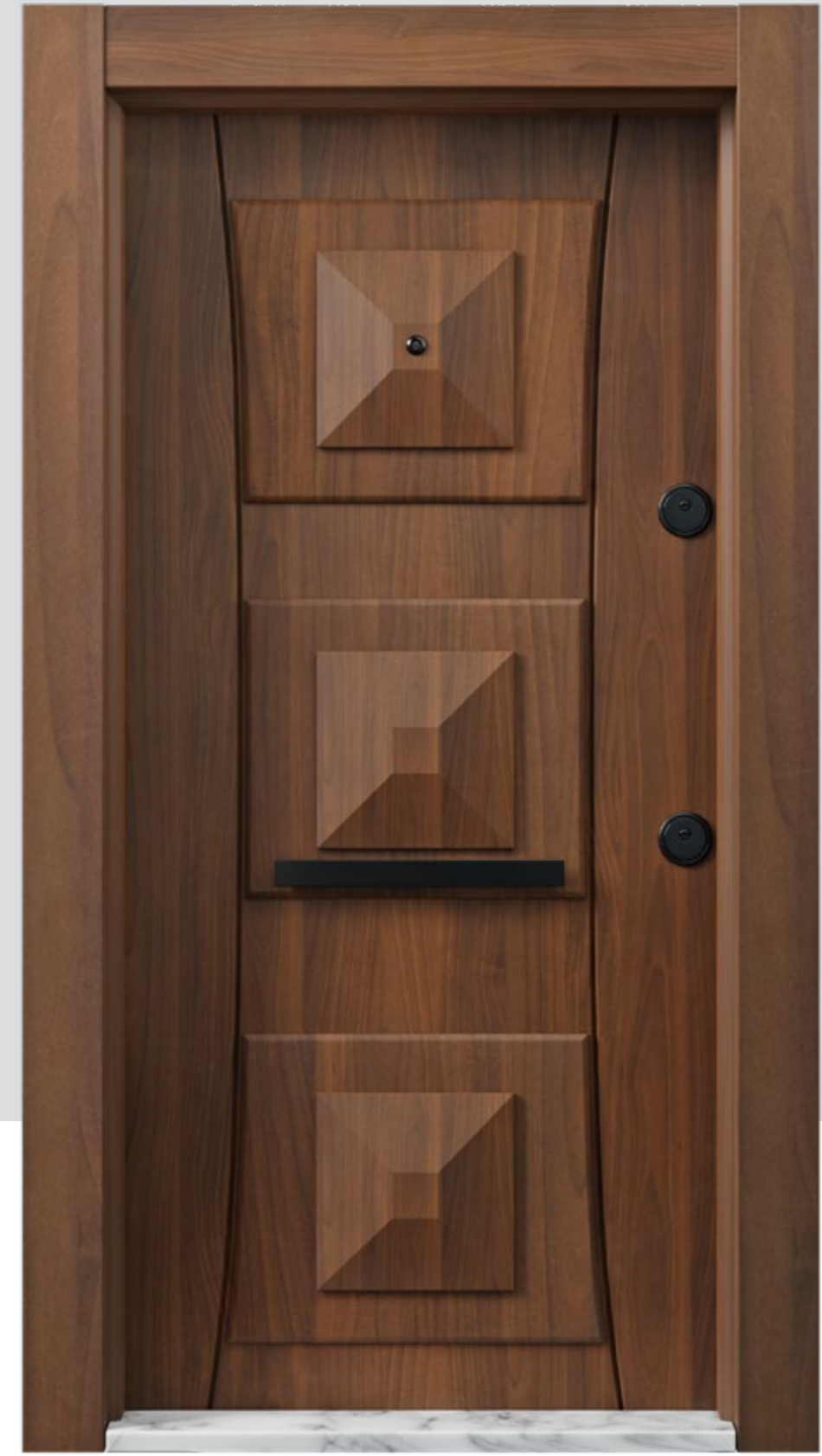

PVC EMBOSSED DOORS

01 B E X



PVC EMBOSSED DOORS

02 B E X



PVC EMBOSSED DOORS

01 B E X

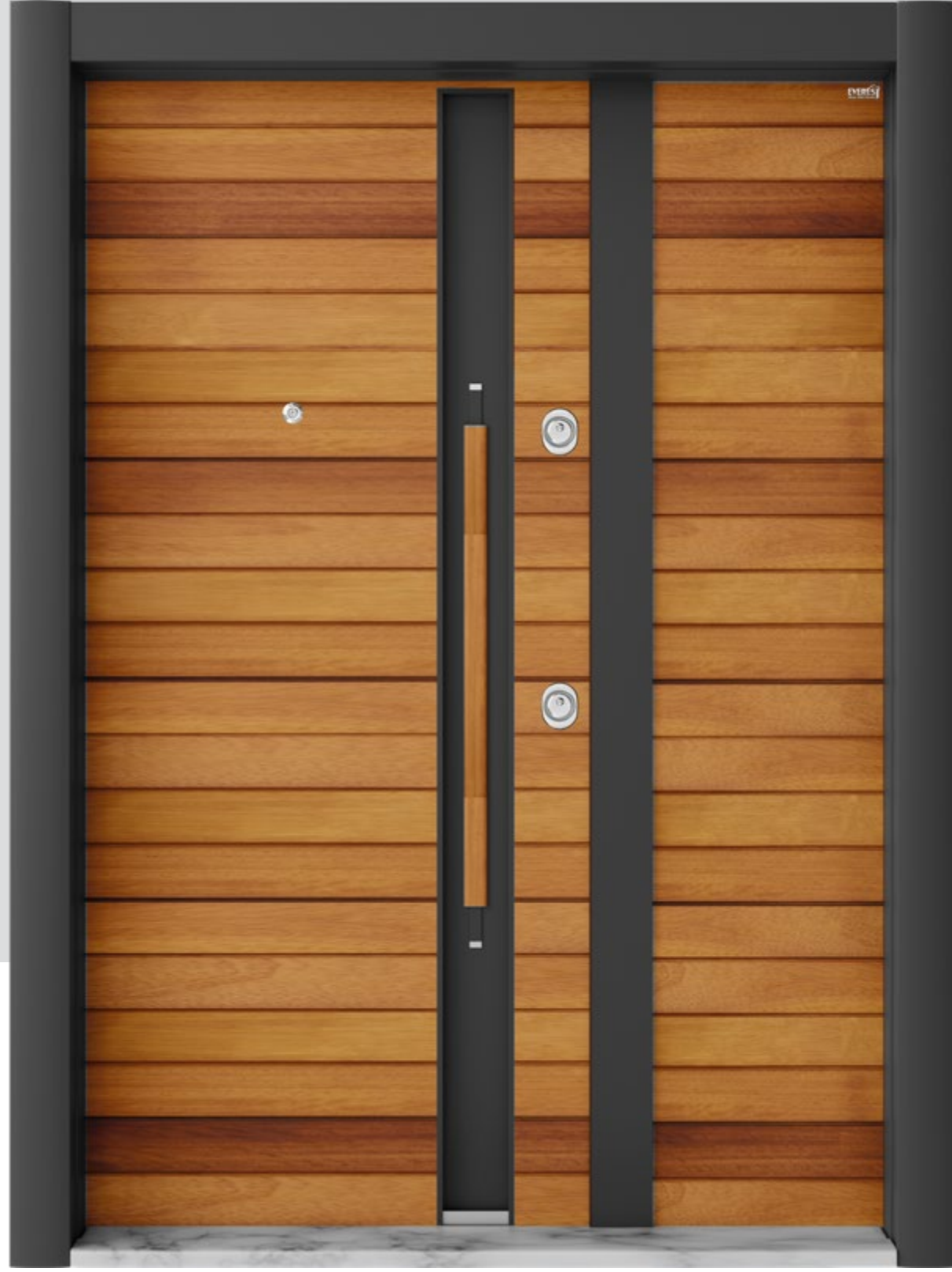

PVC EMBOSSED DOORS

02 B E X

PVC EMBOSSED DOORS



PVC EMBOSSED DOORS



PVC EMBOSSED DOORS



PVC EMBOSSED DOORS

Ayarlı Kasa

Adjustable Frame

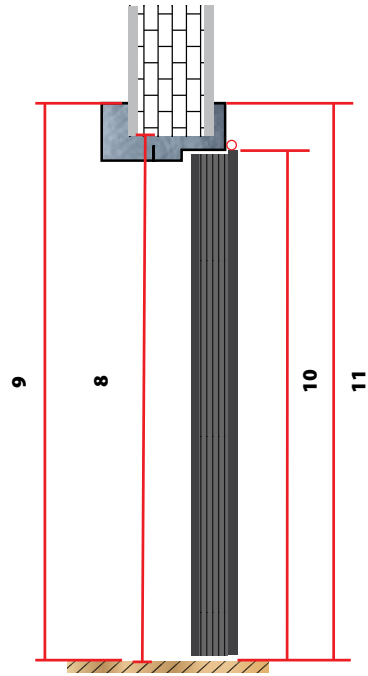

- | | | |
|--|--|--|
| 1 Kasa Boşluğu (En)
Leaf (Wing) Width
87-90-93-97-100-103 cm | 5 Dış Pervaz Bitimi
Exterior Moldings Border
104-107-110-114-117-120 cm | 9 Dış Üst Pervaz Bitimi
Overall Height (Exterior Moldings)
205-208-211-215-218-221 cm |
| 2 İç Pervaz Bitimi (En)
Interior Moldings Border (width)
104-107-110-114-117-120 cm | 6 Dış Pervaz Bitimi
Exterior Moldings
10 cm | 10 Kanat Boşluğu (Yükseklik)
Leaf (Wing) Height
197-200-203-207-210-213 cm |
| 3 İç Pervaz Genişliği
Interior Moldings Border
8,5 cm | 7 Duvar Kalınlığı
Wall Thickness
15-20 cm/ 20-25 cm/ 25-30 cm | 11 İç Üst Pervaz Bitimi
Overall Height (Interior Moldings)
205-208-211-215-218-221 cm |
| 4 Duvar Boşluk (En)
Wall Gap (Width)
94-97-100-104-107-110 cm | 8 Duvar Boşluk (Boy)
Wall Gap (height)
200-203-206-210-213-216 cm | |

İtalyan Kasa

Italian Frame

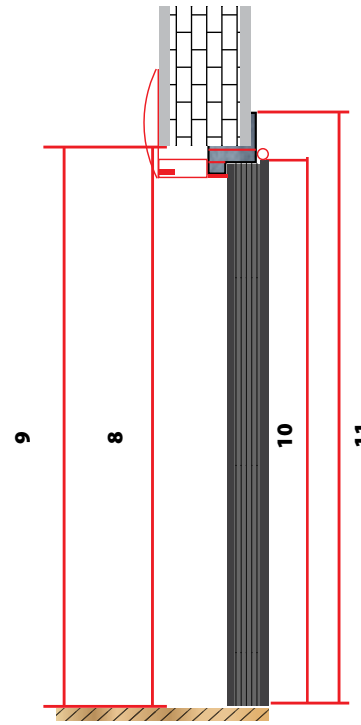

- | | | |
|--|--|--|
| 1 Kasa Boşluğu (En)
Leaf (Wing) Width
87-90-93-97-100-103 cm | 5 Dış Pervaz Bitimi
Exterior Moldings Border
95-98-101-105-108-111 cm | 9 Dış Üst Pervaz Bitimi
Overall Height (Exterior Moldings)
201-204-207-211-214-217 cm |
| 2 İç Pervaz Bitimi (En)
Interior Moldings Border (width)
104-107-110-114-117-120 cm | 6 Dış Pervaz Bitimi
Exterior Moldings
6 cm | 10 Kanat Boşluğu (Yükseklik)
Leaf (Wing) Height
197-200-203-207-210-213 cm |
| 3 İç Pervaz Genişliği
Interior Moldings Border
8,5 cm | 7 Duvar Kalınlığı
Wall Thickness
18-20 cm/ 20-22 cm/ 22-24 cm | 11 İç Üst Pervaz Bitimi
Overall Height (Interior Moldings)
205-208-211-215-218-221 cm |
| 4 Duvar Boşluk (En)
Wall Gap (Width)
97-100-104-107-110-113 cm | 8 Duvar Boşluk (Boy)
Wall Gap (height)
202-205-208-212-215-218 cm | 12 Dış Ahşap Pervaz
Exterior Wood Moldings
12 cm |

Corner Kasa

Corner Frame

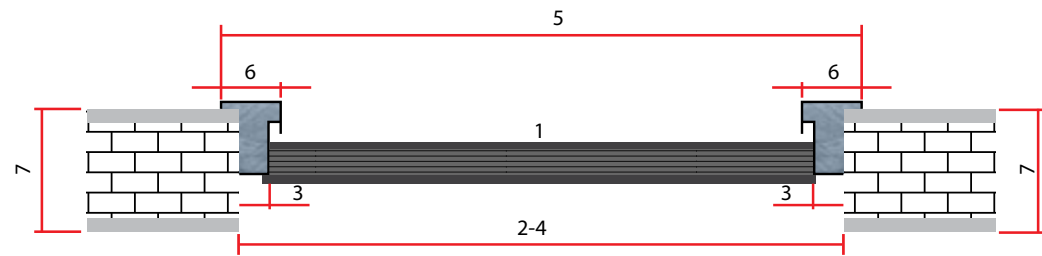
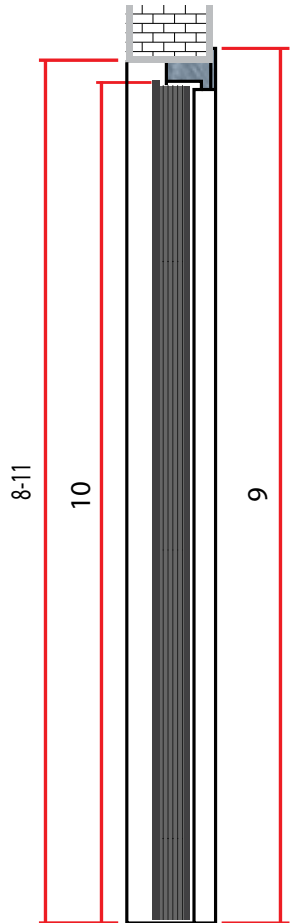

- | | | |
|--|--|--|
| 1 Kasa Boşluğu (En)
Leaf (Wing) Width
87-90-93-97-100-103 cm | 5 Dış Pervaz Bitimi
Exterior Moldings Border
103-106-109-113-116-119 cm | 9 Dış Üst Pervaz Bitimi
Overall Height (Exterior Moldings)
205-208-211-215-218-221 cm |
| 2 İç Pervaz Bitimi (En)
Interior Moldings Border (width)
95-98-101-105-108-111 cm | 6 Dış Pervaz Bitimi
Exterior Moldings
10 cm | 10 Kanat Boşluğu (Yükseklik)
Leaf (Wing) Height
197-200-203-207-210-213 cm |
| 3 İç Pervaz Genişliği
Interior Moldings Border
5 cm | 7 Duvar Kalınlığı
Wall Thickness
15-20-25-30 cm | 11 İç Üst Pervaz Bitimi
Overall Height (Interior Moldings)
201-204-207-211-214-217 cm |
| 4 Duvar Boşluk (En)
Wall Gap (Width)
97-100-104-107-110-113 cm | 8 Duvar Boşluk (Boy)
Wall Gap (height)
202-205-208-212-215-218 cm | |

Sol Kapı

Left Door

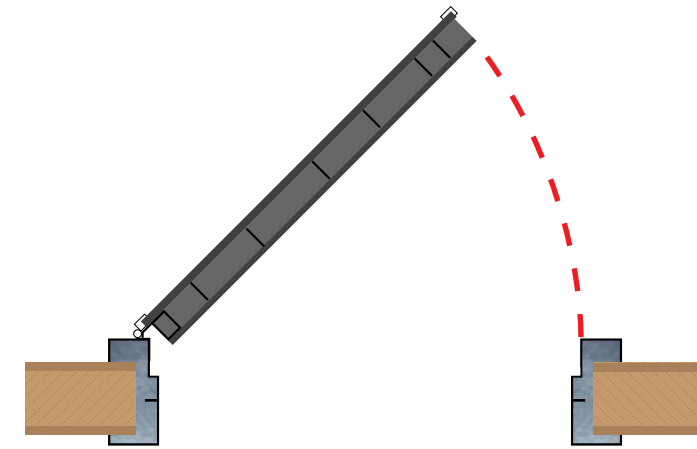

Sağ Kapı

Right Door

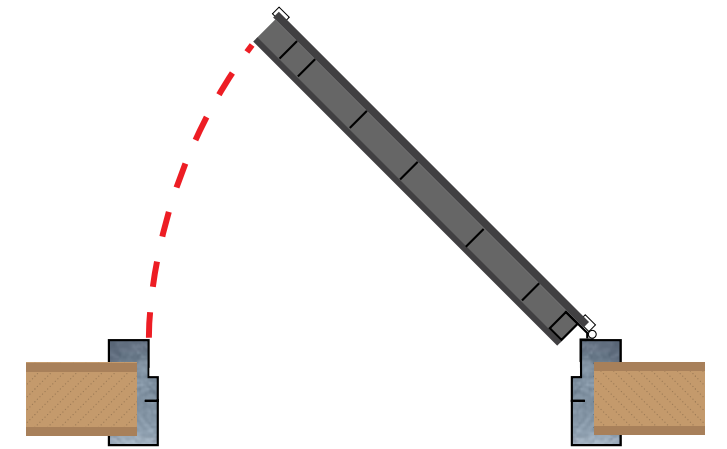

Teknik Detaylar | Technical Details

Kilit Sistemleri
Lock Systems

Merkezi Kilit Sistemi
Central Lock System

Yarı Merkezi Kilit Sistemi
Semi Central Lock System

Monoblok Kilit Sistemi
Monoblock Lock System

Kancalı Kilit Sistemi
Hook Lock System

Teknik Detaylar | Technical Details

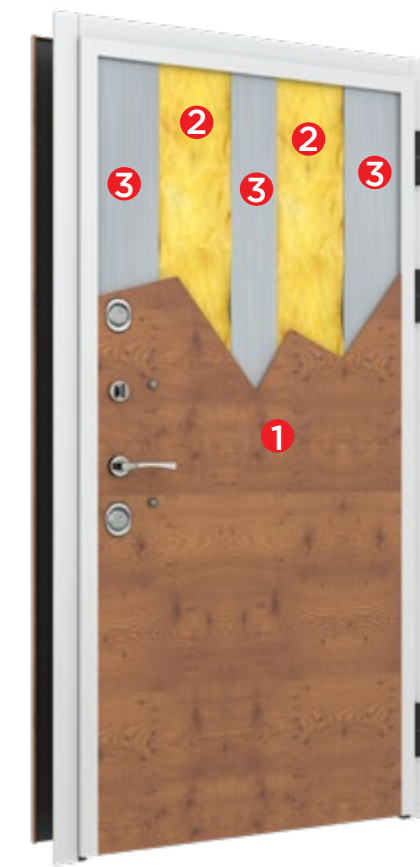
Kanat İç Görünümü
Wing Interior View

- 1 Kanat İç Ahşabı
Internal Wood Of Leaf
- 2 Taş Yünü
Rockwool
- 3 Omurga Destek Sacları
Luxury Leaf Shutter
- 4 Çelik Ana Gövde
Steel Main Body
- 5 Kanat Dış Ahşabı
External Wood Of Leaf

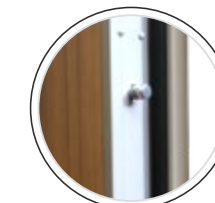

Gizli Emniyet Kilidi
Hidden Security Latch



Lüks Kanat Kesit
Luxury Part Of The Leaf



Dümbün
Peephole



WC Mandalı
WC Latch Lock



Menteşe
Hinge

Kapı Kolları Door Handles



EV - ÇKL - 001
Pull Handle



EV - ÇKL - 002
Pull Handle



EV - ÇKL - 003
Pull Handle



EV - ÇKL - 005
Pull Handle



EV - ÇKL - 007
Pull Handle



EV - ÇKL - 008
Pull Handle



EV - ÇKL - 010
Pull Handle



EV - ÇKL - 011
Pull Handle



EV - ÇKL - 012
Pull Handle



EV - ÇKL - 013
Pull Handle



EV - ÇKL - 014
Pull Handle

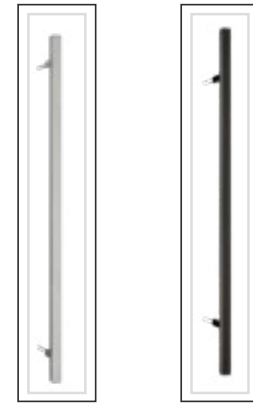

EV - ÇKL - 015 EV - ÇKL - 016
Pull Handle Pull Handle



EV - RK - 013
Lever Handle



EV - RK - 014
Lever Handle



EV - RK - 015
Lever Handle



EV - RK - 016
Lever Handle

Kilit Sistemi Lock Systems

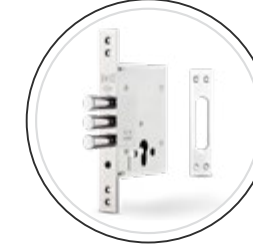

EV - KLT - 001
Monoblok

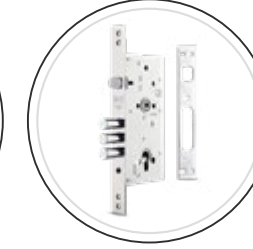

EV - KLT - 002
Kancalı

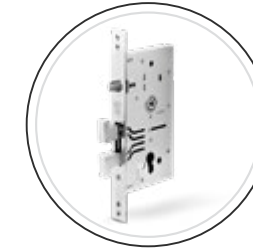

EV - KLT - 003
Yarı Merkezi
Half Central

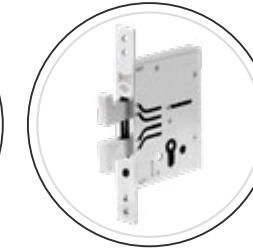

EV - KLT - 004
Merkezi Kilit
Central Lock

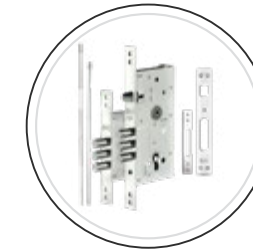

EV - KLT - 003
Yarı Merkezi
Half Central

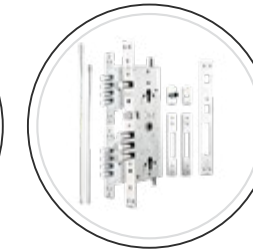

EV - KLT - 004
Merkezi Kilit
Central Lock

Anahtarlar Keys



EV - A - 001
Sistem Barel



EV - A - 002
German Barel

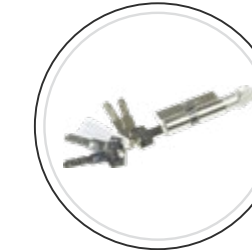

EV - A - 003
Bilyalı Mandallı Barel

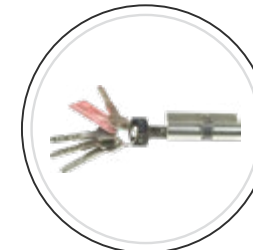

EV - A - 004
Bilyalı Barel



EV - A - 005
German Mandallı Barel

Diğer Aksesuarlar Other Accessories



EV - DA - 001
Door Knocker



EV - DA - 002
Door Knocker



EV - DA - 003
Door Knocker



EV - DA - 004
Door Knocker



EV - DA - 005
Door Viewer (Big)



EV - DA - 006
Door Viewer (Small)

DOCUMENTS

As a company, we accept the safety of our consumers as targets and We have proved this objective with our documents in line with this goal.



dolphindoors.com

To get to know us better
**don't forget to follow on
Instagram!**

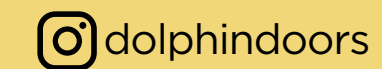

security doors

*Dolphin Doors is not responsible for any color or typographical errors in this catalog.
Dolphin Doors reserves the right to make product changes without prior notice.
All rights to the catalog's products are reserved.*



www.dolphindoors.com



Tesano - 10th Mukose St,- Abeka,
Accra - Ghana
+233 302 986 345 +233 302 252 027
info@dolphindoors.com

Road of Justice - Obom, Kasa
Central Region - Ghana
+ 233 302 986 345 +233 302 252 027